This is an electronic reprint of the original article.
This reprint may differ from the original in pagination and typographic detail.

Mehrasa, Majid; Sharifzadeh, Mohammad; Sheikholeslami, Abdolreza; Pouresmaeil, Edris; Catalao, Joao P.S.; Al-Haddad, Kamal

A control strategy based on the upper and lower's arms modulation functions of MMC in HVDC applications

Published in:

Proceedings of the 19th IEEE International Conference on Industrial Technology, ICIT 2018

DOI:

[10.1109/ICIT.2018.8352471](https://doi.org/10.1109/ICIT.2018.8352471)

Published: 27/04/2018

Document Version

Peer reviewed version

Please cite the original version:

Mehrasa, M., Sharifzadeh, M., Sheikholeslami, A., Pouresmaeil, E., Catalao, J. P. S., & Al-Haddad, K. (2018). A control strategy based on the upper and lower's arms modulation functions of MMC in HVDC applications. In *Proceedings of the 19th IEEE International Conference on Industrial Technology, ICIT 2018* (Vol. 2018-February, pp. 1873-1878). IEEE. <https://doi.org/10.1109/ICIT.2018.8352471>

This material is protected by copyright and other intellectual property rights, and duplication or sale of all or part of any of the repository collections is not permitted, except that material may be duplicated by you for your research use or educational purposes in electronic or print form. You must obtain permission for any other use. Electronic or print copies may not be offered, whether for sale or otherwise to anyone who is not an authorised user.

A Control Strategy based on the Upper and Lower's Arms Modulation Functions of MMC in HVDC Applications

Majid Mehrasa¹, Mohammad Sharifzadeh², Abdolreza Sheikholeslami¹, Edris Pouresmaeil³, João P.S. Catalão^{4,5} and Kamal Al-Haddad²,

¹Department of Computer and Electrical Engineering, Babol Noshirvani University, Iran

²GREPCI, Ecole de Technologie Supérieure, University of Quebec, Montreal, Canada

³Department of Electrical Engineering and Automation, Aalto University, 02150 Espoo, Finland

⁴C-MAST, University of Beira Interior, R. Fonte do Lameiro, 6201-001 Covilhã, Portugal

⁵INESC TEC and Faculty of Engineering of the University of Porto, R. Dr. Roberto Frias, 4200-465 Porto, Portugal

Abstract— A control strategy is proposed in this paper based on considering the upper and lower's arms modulation functions of a MMC in HVDC applications. The designed modulation-functions-based controller is consisted of the modulation index and phase that are accurately evaluated according to ac-side voltage, MMC voltage and current components in a-b-c reference frame. Two main contributions of the proposed control strategy over the other existing control techniques are robust against the MMC parameter variations and simplicity operation that causes MMC to perform the ac/dc conversion for the HVDC applications. The simulation results verify the ability of the proposed control strategy at approaching to the stable performance of MMC under various operating conditions.

Keywords— HVDC Applications, modular multilevel converters (MMCs), the upper and lower's arms modulation functions.

I. INTRODUCTION

Developing of multilevel converters particularly Modular Multilevel Converters (MMCs) as well as improving the performance of modulation techniques has been led to their wide utilization in industrial applications [1-7]. The significant features of MMCs included an easy redundancy of SMs, modular structure, simplicity in the fault identification and lead to the use of these converters in many industrial applications such as HVDC transmission systems [8-10]. Recently, many literatures have concentrated on designing the effective control strategies for stable operation of MMCs [11-12].

A carrier-phase-shift pulse-width-modulation-based MMC is considered in [13] in which an improved circulating current controller strategy based on a digital plug-in repetitive controller was applied to this converter. This proposed controller has the features consisted of simplicity, versatility, and better operation at eliminating the circulating harmonic current compared to the conventional PI regulator [13]. A new pulse-width modulation (PWM) technique and capacitor voltage balancing method based on phase voltage redundant states has been suggested for controlling MMC in different industrial application [14].

The required switching states numbers for the MMC input current, circulating current, and capacitor voltage-balancing controller strategies have been decreased by MPC-based cost functions [15]. First cost function is responsible of regulating the input current without considering redundancy, the second one has the duty of regulating the fluctuations of the dc-side current, the transient specifications of the unbalanced voltage condition, the circulating current and the third one focused on approaching to the capacitor voltage balancing and decreasing the SM's switching frequency [15].

In [16], a control technique based on the use of a new dynamic model is proposed for MMC in which a comprehensive stability analysis is also performed. Also, a phase-shifted carrier modulation and switching-cycle state-space modeling based controller strategy have been considered for MMC in [17] and [18], respectively. Generally, the importance of designing an effective controller for MMC [19]-[21] should be highly noticed in today researches.

The upper and lower arms modulation functions-based control technique consisted of the detailed modulation index and phase angle is proposed in this paper to provide an accurate performance for MMC in HVDC application. Both modulation index and phase angle are achieved through shaping the voltages of the MMC's upper and lower arms based on an accurate analysis of all MMC voltages and currents in the a-b-c reference frame.

The proposed modulation function based controller which completely depends on MMC input voltages and currents characteristics is robustness against the MMC parameters alterations. The simulation results based on MATLAB/SIMULINK prove the complete ability of the designed modulation-based controller strategy at approaching to desired values of all considered state variables.

II. MMC'S AC-SIDE VOLTAGES

Fig.1.a shows the general diagram of a 3-phase MMC. In addition, the "2n" numbers of sub-modules are used in each arm with their accurate structure as illustrated in Fig.1.b. As it can be seen from Fig.1.b, two complementary IGBT-Diode

switches will be switched on or off in this way that each SM is located at either connected or bypassed state according to its suitable switching claims and control technique requirements.

An inductor is employed in all arms of MMC according to Fig.1.a to reduce the circulating current and also limit the fault current during a dc side fault. Also, both arm losses and the inner inductor resistance can be shown by the series resistor of MMC's arm.

A. The ac-Side Voltage dynamic calculation

In this sub-section, the ac-side voltages of MMC in a-b-c reference frame are accurately analyzed. These voltages can highly impact on the operation of the MMC's SMs. It can be seen from Fig.1.a that there is a direct relationship between the ac-side voltages and both MMC's ac-side variables and parameters. Considering the MMC's ac-side voltage and current of phase "a" as the following,

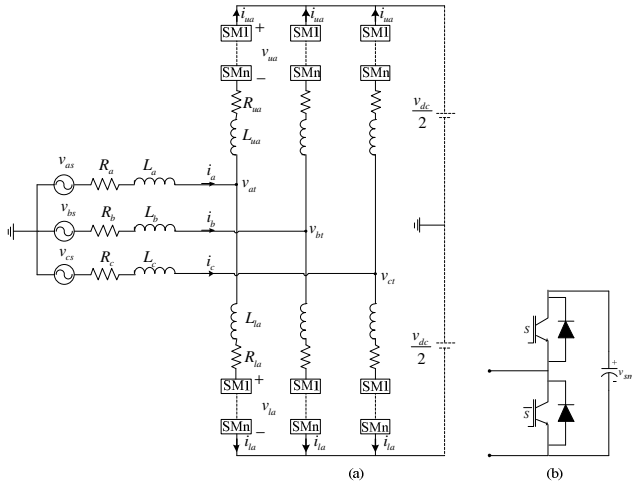

Fig. 1. (a) The Considered 3-phase MMC, (b) SM

$$v_{as} = v_m \cos(\omega t), i_a = I_{ma} \cos(\omega t + \alpha_a) \quad (1)$$

According to the 3-phase MMC structure illustrated as Fig.1.a, the input and the ac-side voltages dynamic equation of phase "a" is achieved as,

$$v_{as} - v_{at} = L_a \frac{di_a}{dt} + R_a i_a \quad (2)$$

By substituting (1) into (2), the detailed relationship of the phase "a" ac-side voltage is obtained as (3),

$$v_{at} = \sqrt{\frac{L_a^2 I_{ma}^2 \omega^2 + R_a^2 I_{ma}^2 + v_m^2}{2v_m L_a I_{ma} \omega \sin(\alpha_a)}} \times \cos \left(\omega t - \frac{\pi}{2} + \tan^{-1} \left(\frac{v_m + L_a I_{ma} \omega \sin(\alpha_a)}{-R_a I_{ma} \cos(\alpha_a)} \right) \right) \quad (3)$$

To further accurate analysis, (3) can be restated as (4),

$$v_{kt} = \sqrt{\frac{L_k^2 I_{mk}^2 \omega^2 + R_k^2 I_{mk}^2 + v_m^2}{2v_m L_k I_{mk} \omega \sin(\alpha_k)}} \times \cos \left(\omega t + \frac{2\pi j}{3} - \frac{\pi}{2} + \tan^{-1} \left(\frac{v_m + L_k I_{mk} \omega \sin(\alpha_k)}{-R_k I_{mk} \cos(\alpha_k)} \right) \right) \quad (4)$$

We have $j=0, -1$ and 1 for the 3-phases of "a", "b" and "c", respectively. The phases sign of "a", "b" and "c" is represented by the indices of k . Equation (4) shows the general form of three phase ac-side voltages. As it can be understood from (4), the MMC ac-side voltages can be significantly affected through the MMC input parameters and variables.

III. PROPOSED MODULATION FUNCTION EVALUATION

Two proposed modulation functions based on the MMC upper and lower's arms will be achieved in this section by the use of the ac-side voltages general form. The voltages due to all the upper and lower SMs are aimed to provide the required signals of the SM switches. Thus, the following equations can be achieved by applying KVL's law on phase "a" arms of the MMC as,

$$v_{at} - v_{dc} / 2 = L_{au} \frac{di_{au}}{dt} + R_{au} i_{au} - v_{au} \quad (5)$$

$$v_{at} + v_{dc} / 2 = L_{al} \frac{di_{al}}{dt} + R_{al} i_{al} + v_{al} \quad (6)$$

By summing up two equations (5) and (6) and also assuming $L_{au} = L_{al} = L_{at}$, (7) can be driven as,

$$v_{at} - v_{au} = 2v_{at} - L_{at} \frac{di_a}{dt} - R_{at} i_a \quad (7)$$

Substituting (1) and (3) into (7), the following relationship can be obtained as,

$$v_{at} - v_{au} = \sqrt{\frac{(2L_a + L_{at})^2 I_{ma}^2 \omega^2 + (2R_a + R_{at})^2 I_{ma}^2 + 4v_m^2 + 4v_m (2L_a + L_{at}) I_{ma} \omega \sin(\alpha_a)}{-4v_m (2R_a + R_{at}) I_{ma} \cos(\alpha_a)}} \times \cos \left(\omega t - \frac{\pi}{2} + \tan^{-1} \left(\frac{2v_m + (2L_a + L_{at}) I_{ma} \omega \sin(\alpha_a)}{-(2R_a + R_{at}) I_{ma} \cos(\alpha_a)} \right) \right) \quad (8)$$

To provide more accurate explanations, (9) can be achieved in a general form by (8) as,

$$v_{kl} - v_{ku} = \sqrt{\frac{(2L_k + L_{kt})^2 I_{mk}^2 \omega^2 + (2R_k + R_{kt})^2 I_{mk}^2}{4v_m^2 + 4v_m (2L_k + L_{kt}) I_{mk} \omega \sin(\alpha_k)} - 4v_m (2R_k + R_{kt}) I_{mk} \cos(\alpha_k)} \times \cos\left(\omega t + \frac{2\pi j}{3} - \frac{\pi}{2} + \operatorname{tag}^{-1} \left(\frac{\begin{bmatrix} 2v_m + (2L_k + L_{kt}) I_{mk} \omega \sin(\alpha_k) \\ -(2R_k + R_{kt}) I_{mk} \cos(\alpha_k) \end{bmatrix}}{\begin{bmatrix} (2L_k + L_{kt}) I_{mk} \omega \cos(\alpha_k) \\ +(2R_k + R_{kt}) I_{mk} \sin(\alpha_k) \end{bmatrix}} \right) \right) \quad (9)$$

The relationship of “ $v_{kl} - v_{ku}$ ” is employed at achieving the reference waveforms of SLPWM. Assuming the reference values of the MMC input currents and voltages specifications as I_{mk}^* , v_m^* and α_k^* , the modulation index of the proposed modulation functions can be obtained as,

$$m_k = \frac{V_{kt}(L_k, R_k, L_{kt}, R_{kt}, I_{mk}^*, v_m^*, \alpha_k^*)}{v_{dc}} = \frac{1}{v_{dc}} \sqrt{\frac{(2L_k + L_{kt})^2 I_{mk}^{*2} \omega^2 + (2R_k + R_{kt})^2 I_{mk}^{*2} + 4v_m^{*2}}{4v_m^* (2L_k + L_{kt}) I_{mk}^* \omega \sin(\alpha_k^*) - 4v_m^* (2R_k + R_{kt}) I_{mk}^* \cos(\alpha_k^*)}} \quad (10)$$

As it can be seen in (10), the desired values of the designed PWM are altered through the MMC input and arm parameters as well as the ac-side voltages and currents specifications of MMC. According to (9) and (10), and also considering the input variables desired values, the proposed modulation functions-based controller is driven according to (11) and (12),

$$u_{ku} = m_k \cdot \left(\begin{array}{c} 1 - \cos\left(\omega t + \frac{2\pi j}{3} - \frac{\pi}{2} + \operatorname{tag}^{-1} \left(\frac{\begin{bmatrix} 2v_m \\ +(2L_k + L_{kt}) I_{mk} \omega \sin(\alpha_k) \\ -(2R_k + R_{kt}) I_{mk} \cos(\alpha_k) \end{bmatrix}}{\begin{bmatrix} (2L_k + L_{kt}) I_{mk} \omega \cos(\alpha_k) \\ +(2R_k + R_{kt}) I_{mk} \sin(\alpha_k) \end{bmatrix}} \right) \right) \end{array} \right) \quad (11)$$

$$u_{kl} = m_k \cdot \left(\begin{array}{c} 1 + \cos\left(\omega t + \frac{2\pi j}{3} - \frac{\pi}{2} + \operatorname{tag}^{-1} \left(\frac{\begin{bmatrix} 2v_m \\ +(2L_k + L_{kt}) I_{mk} \omega \sin(\alpha_k) \\ -(2R_k + R_{kt}) I_{mk} \cos(\alpha_k) \end{bmatrix}}{\begin{bmatrix} (2L_k + L_{kt}) I_{mk} \omega \cos(\alpha_k) \\ +(2R_k + R_{kt}) I_{mk} \sin(\alpha_k) \end{bmatrix}} \right) \right) \end{array} \right) \quad (12)$$

The parameters of v_{at} and θ_{at} can be achieved as (13),

$$V_{at} = \sqrt{\frac{(2L_a + L_{at})^2 I_{ma}^2 \omega^2 + (2R_a + R_{at})^2 I_{ma}^2}{+4v_m^2 + 4v_m (2L_a + L_{at}) I_{ma} \omega \sin(\alpha_a)} - 4v_m (2R_a + R_{at}) I_{ma} \cos(\alpha_a)} \quad (13)$$

$$\theta_{at} = \operatorname{tag}^{-1} \left(\frac{\begin{bmatrix} 2v_m + (2L_a + L_{at}) I_{ma} \omega \sin(\alpha_a) \\ -(2R_a + R_{at}) I_{ma} \cos(\alpha_a) \end{bmatrix}}{\begin{bmatrix} (2L_a + L_{at}) I_{ma} \omega \cos(\alpha_a) \\ +(2R_a + R_{at}) I_{ma} \sin(\alpha_a) \end{bmatrix}} \right)$$

Assuming u_{ku} and u_{kl} , the obtained modulation index and functions are drawn based on Fig.2 for $I_{mk}^* = 50A$ and $\alpha_k^* = 0$. According to Fig.2, the index modulation approximately approaches to unit. The MMC parameters and ac-side currents can impact on the designed modulation functions as it is analyzed in details in the following sub-section.

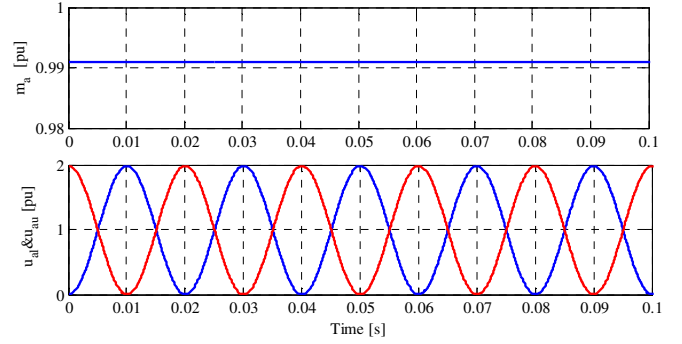

Fig. 2. The designed modulation index and function based on the MMC parameters of Table I.

A. The Proposed Modulation Function Evaluation with Parameters Variations

The effects of parameters changes on two modulation functions are surveyed in this sub-section. The MMC parameters specifications can be seen in Table I. For assessing the system parameters effects on the proposed modulation functions, the MMC parameters are altered according to Table II. While the parameters of MMC increase, the designed modulation indexes can be decreased according to Fig.3.

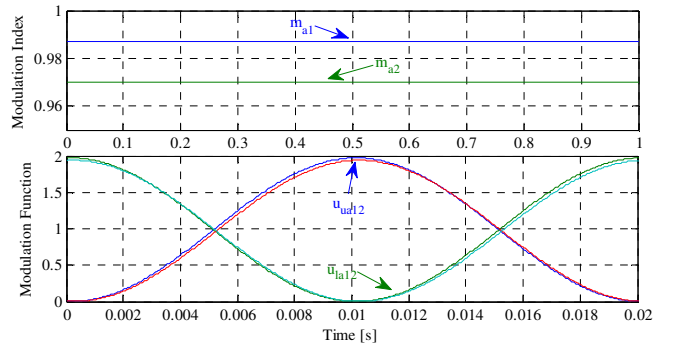

Fig. 3. The designed modulation index and function according to the new parameters of Table II.

In addition to the index changes, another point that can be understood from Fig.3 is the phase variation of the modulation functions-based controllers in two operating points. The shift can impact on the performance of the designed modulation function control technique-based MMC.

IV. SIMULATION AND RESULTS

The ability of the designed control strategy is evaluated in this sub-section. Fig.4 illustrates the general structure of the proposed modulation functions with all control process.

In order to employ the designed modulation-based control strategy based on the system parameters specified as tables I and II, MATLAB/SIMULINK environment in discrete mode is utilized along with the assessment of MMC performance as a ac/de converter in HVDC transmission system. The sample time of the simulation is chosen one micro second. On the other hand, the SM capacitors allocate an initial value of 3 kV in all simulation process.

TABLE I
SIMULATED SYSTEM PARAMETERS

Parameter	Value
Ac-side Resistance	0.6 Ohm
Ac-side Inductance (L_{abc})	15 mH
Resistance of Arm	0.5 Ohm
Inductance of Arm	5 mH
AC-side voltage	6 kV
DC-link voltage	12kV
Sub-Module Number Per Arm	4
AC Frequency	50 Hz
PWM Frequency	10 kHz
Capacitance of SM	5 mF
Voltage of SM	3 kV

TABLE II
CHANGES IN MMC'S PARAMETERS IN CONDITION 2

Parameter	Value
Ac-side Resistance	1.2 Ohm
Ac-side Inductance (L_{abc})	25 mH
Resistance of Arm	1.5 Ohm
Inductance of Arm	10 mH
AC-side voltage	6 kV
I_{mk}	50 A
α_k	0

A. Parameters Variation Assessment

The proposed modulation functions of u_{ku} and u_{kl} can be used in the reference waveforms of proposed PWM in all simulation process. It is understood that controlling both amplitude and phase angle of the designed control strategy is performed by the alterations of the MMC's arms and input parameters. In the interval of [0, 0.2] second, the converter acts in its stable operation condition along with ac side and arm parameters shown in table I. Then, the MMC parameters changes happen according to table II at $t=0.2$ s. As it is depicted in Fig.5, the SM's voltages of phase "a" can be remained at their reference value 3 kV using the steady state values of the MMC parameters. After the parameters alterations, the

proposed modulation function-based control technique may be accurately control SM's voltages, except for the small deviations from the reference value at $t=0.2$ s.

The dc-side voltage of MMC is illustrated in Fig.6. As the initial response of the simulation process, MMC can reach the desired dc-link voltage after a very small deviation from 1.2 kV. Along with a slight undershoot, the proposed modulation functions-based SLPWM can provide the reference dc-link voltage for the MMC after parameters changes. Fig.7 shows the MMC current in phase "a" under both steady and dynamic operating conditions. Based on Fig.7, the proposed controller can lead to the requested current with the desired maximum value of 50 A for MMC under the parameters sets given in table I and II, regardless of the slight transient responses.

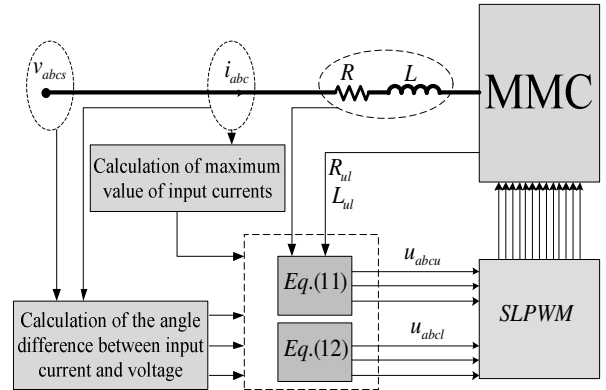

Fig. 4. The general description of the designed controller.

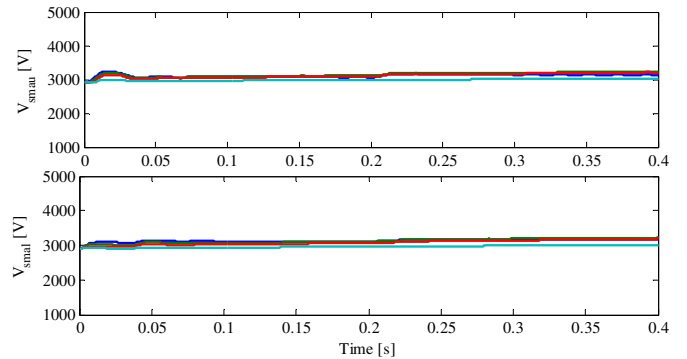

Fig. 5. SM's voltages of MMC with parameters variations.

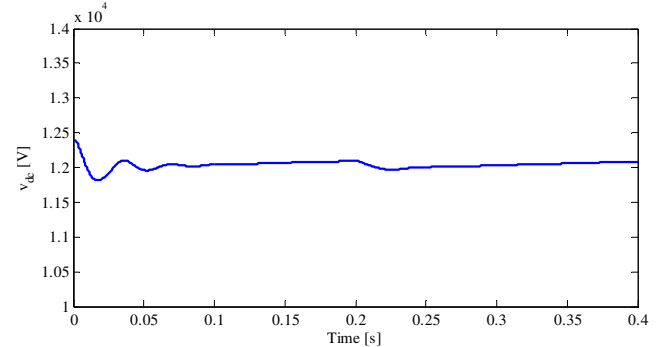

Fig. 6. Dc-link voltage of MMC with parameters variations.

Figure 8 illustrates the MMC's active and reactive power tracking under both steady and dynamic values of the MMC's parameters. It can be understood from Fig.8 that along with their proportional changes, the MMC active and reactive

powers can reach their reference values even after the MMC parameters alterations.

A well-designed controller for MMC should be able approximately to be achieved the zero value for circulating currents. Fig.9 verifies the ability of the designed modulation-based control strategy at reaching minimized circulating currents of MMC. According to this figure, the MMC circulating current in phase "a" can be kept around an acceptable value in both states of the constant and varied MMC's parameters.

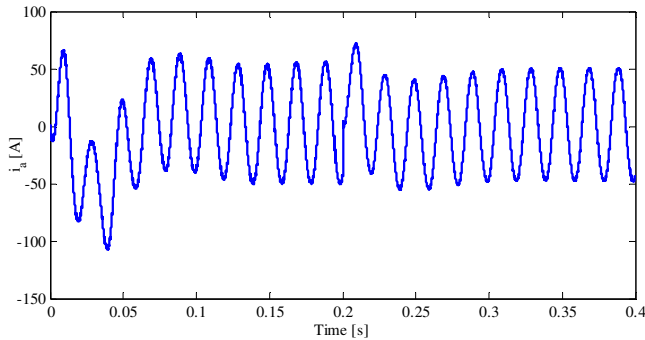

Fig. 7. MMC's current of phase 'a' with parameters variations

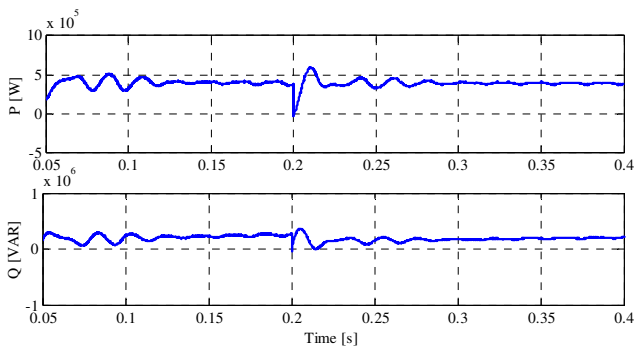

Fig.8. . The active and reactive power of MMC with parameters variations

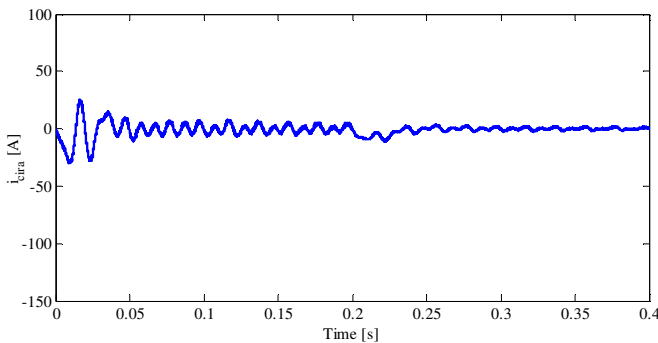

Fig. 9. Circulating current of MMC in phase "a" with parameters variations.

V. CONCLUSION

Two novel modulation functions with specified phase angle and index were proposed in this paper to effectively provide a stable operation for MMC in HVDC application under steady state and parameter changes conditions. With the aim of achieving the detailed relationship for the ac-side voltage, evaluating all voltages and currents of MMC in a-b-c reference frames was accomplished. Using the obtained ac-side voltage, the combination of the MMC's upper and lower arm voltages was driven. The proposed modulation functions were achieved

by the use of this combination in which both their modulation index and phase angle were dependent on the MMC parameters as well as the MMC input voltages and currents specifications. With the aim of more analyzing the operation of the proposed control technique, the parameters variations effects on the proposed modulation function-based controller and its index were thoroughly assessed during a specified range of operation points. The main contribution of the proposed controller was very simple designing in a-b-c reference frame that can additionally provide robustness operation against the parameters alterations of MMC. MATLAB/SIMULINK environment was utilized to verify the ability of the designed modulation function-based controller at providing the stable operation for MMC.

REFERENCES

- [1] Mohammad Sharifzadeh, H. Vahedi, R. Portillo, M. Khenar, A. Sheikholeslami, L. Franquelo, and K. Al-Haddad, "Hybrid SHM-SHE Pulse Amplitude Modulation for High Power Four-Leg Inverter," *IEEE Transactions on Industrial Electronics*, vol. 63, no. 11, pp. 7234 - 7242, 2016.
- [2] Mohammad Sharifzadeh, A. Sheikholeslami, H. Vahedi, H. Ghoreishy, P.-A. Labbé, and K. Al-Haddad, "Optimised harmonic elimination modulation extended to four-leg neutral-point-clamped inverter," *IET Power Electronics*, vol. 9, no. 3, pp. 441-448, 2016.
- [3] Mohammad Sharifzadeh, H. Vahedi, A. Sheikholeslami, P.-A. Labbé, and K. Al-Haddad, "Hybrid SHM-SHE Modulation Technique for a Four-Leg NPC Inverter With DC Capacitor Self-Voltage Balancing," *IEEE Transactions on Industrial Electronics*, vol. 62, no. 8, pp. 4890-4899, 2015.
- [4] R. Portillo, Mohammad Sharifzadeh, H. Vahedi, L. G. Franquelo, and K. Al-Haddad, "Improved hybrid SHM-SHE modulation technique for four-leg three-level NPC inverters," in *Industrial Electronics Society, IECON 2015-41st Annual Conference of the IEEE*, 2015, pp. 005415-005420.
- [5] Mohammad Sharifzadeh, H. Vahedi, A. Sheikholeslami, H. Ghoreishy, and A.-H. Kamal, "Selective harmonic elimination modulation technique applied on four-leg NPC," in *Industrial Electronics (ISIE), 2014 IEEE 23rd International Symposium on*, 2014, pp. 2167-2172.
- [6] M. Sharifzadeh, H. Vahedi, C. Cecati, C. Buccella, and K. Al-Haddad, "A generalized formulation of SHM-PAM for cascaded H-bridge inverters with non-equal DC sources," in *Industrial Technology (ICIT), 2017 IEEE International Conference on*, 2017, pp. 18-23.
- [7] M. Sharifzadeh, H. Vahedi, A. Sheikholeslami, H. Ghoreishy, and K. Al-Haddad, "Modified selective harmonic elimination employed in four-leg NPC inverters," in *IECON 2014-40th Annual Conference of the IEEE Industrial Electronics Society*, 2014, pp. 5196-5201.
- [8] M. Mehrasa, E. Pouresmaeil, M. F Akorede, S. Zabih, and J. P. S. Catalão, "Function-Based Modulation Control for Modular Multilevel Converters under Varying Loading and Parameters Conditions," *IET Generation, Transmission and Generation*, vol. 11, n. 12, PP. 3222-30, August. 2017.
- [9] Li, Z., Wang, P., Zhu, H., Chu, Z., Li, Y.: 'An Improved Pulse Width Modulation Method for Chopper-Cell-Based Modular Multilevel Converters', *IEEE Trans. Power Electronic.*, 2012, 27, (8), pp. 3472 - 3481.
- [10] M.A. Perez, S. Bernet, J. Rodriguez, S. Kouro, and R. Lizana, "Circuit Topologies, Modelling, Control Schemes and Applications of Modular Multilevel Converters," *IEEE Trans. Power Electron.*, vol. 30, no. 1, pp. 4-17, Jan. 2015.
- [11] E. Pouresmaeil, M. Mehrasa, M. A. Shokridehaki, E. Rodrigues, and J.P.S. Catalao, "Control of Multilevel Modular Converters for Integration of Distributed Generation Sources into the Power Grid," in *Proc. IEEE International Conference on Smart Energy Grid Engineering (SEGE) 2015*, 1-6.
- [12] Hu, P., Jiang, D.: 'A Level-Increased Nearest Level Modulation Method for Modular Multilevel Converters', *IEEE Trans. Power Electronic.*, 2015, 30, (4), pp. 1836 - 1842.

- [13] M. Zhang, L. Huang, W. Yao, and Z. Lu, "Circulating Harmonic Current Elimination of a CPS-PWM Based Modular Multilevel Converter with Plug-In Repetitive Controller," *IEEE Trans. Power Electron.*, vol. 29, no. 4, pp. 2083 - 2097, April. 2014.
- [14] Zhang, Y., Adam, GP., Lim, TC., Finney, SJ., Williams BW.: 'Analysis of modular multilevel converter capacitor voltage balancing based on phase voltage redundant states', *IET Power Electronics.*, 2012, 5, (6), pp. 726 – 738.
- [15] J.-W. Moon, J.-S. Gwon, J.-W. Park, D.-W. Kang, and J.-M. Kim, "Model Predictive Control With a Reduced Number of Considered States in a Modular Multilevel Converter for HVDC System," *IEEE Trans. Power Del.*, vol. 30, no. 2, pp. 608 - 617, April. 2015.
- [16] M. Mehrasa, E. Pouresmaeil, S. Zabihi and J. P. S. Catalao, "Dynamic Model, Control and Stability Analysis of MMC in HVDC Transmission Systems," *IEEE Transaction on Power Delivery*, vol. 32, no. 3, pp. 1471 - 1482, Feb. 2017.
- [17] Li, B., Yang, R., Xu, D., Wang, G., Wang, W., Xu, D.: 'Analysis of the Phase-Shifted Carrier Modulation for Modular Multilevel Converters', *IEEE Trans. Power Electronic.*, 2015, 30, (1), pp. 297-310.
- [18] J. Wang, R. Burgos, and D. Boroyevich, "Switching-Cycle State-Space Modeling and Control of the Modular Multilevel Converter," *IEEE Journal of Emerging and Selected Topics in Power Electronics*, vol. 2, no. 4, pp. 1159 - 1170, Dec. 2014.
- [19] M. Mehrasa, E. Pouresmaeil, S. Taheri, I. Vechiu, and J. P. S. Catalão, "Novel Control Strategy for Modular Multilevel Converters Based on Differential Flatness Theory," *IEEE Journal of Emerging and Selected Topics in Power Electronics*, DOI: 10.1109/JESTPE.2017.2766047, Oct. 2017.
- [20] M. Mehrasa, E. Pouresmaeil, S. Zabihi, I. Vechiu, and J. P. S. Catalão, "A Multi-Loop Control Technique for the Stable Operation of Modular Multilevel Converters in HVDC Transmission Systems," *International Journal of Electrical Power and Energy Systems*, Oct. 2017.
- [21] P. Wang, X. P. Zhang, P. F. Coventry, and R. Zhang, "Start-Up Control of an Offshore Integrated MMC Multi-Terminal HVDC System With Reduced DC Voltage," *IEEE Trans. Power System.*, vol. pp, no. 99, pp. 1 - 12, Sep. 2015.