This is an electronic reprint of the original article.
This reprint may differ from the original in pagination and typographic detail.

Paatero, Jukka; Lund, Peter

Impacts of energy storage in distribution grids with high penetration of photovoltaic power

Published in:
International Journal of Distributed Energy Sources

Published: 01/01/2007

Document Version
Peer reviewed version

Please cite the original version:
Paatero, J., & Lund, P. (2007). Impacts of energy storage in distribution grids with high penetration of photovoltaic power. *International Journal of Distributed Energy Sources*, 3, 41-46.

This material is protected by copyright and other intellectual property rights, and duplication or sale of all or part of any of the repository collections is not permitted, except that material may be duplicated by you for your research use or educational purposes in electronic or print form. You must obtain permission for any other use. Electronic or print copies may not be offered, whether for sale or otherwise to anyone who is not an authorised user.

IMPACTS OF ENERGY STORAGE IN DISTRIBUTION GRIDS WITH HIGH PENETRATION OF PHOTOVOLTAIC POWER

Jukka V. Paatero*, Peter D. Lund

Advanced Energy Systems

Helsinki University of Technology

P.O. Box 4100, FI-02015 HUT, Finland

* Corresponding author, Phone (358) 9/451-3213, Fax (358) 9/451-3195

E-mail: jukka.paatero@tkk.fi

This is a preprint of an article published in
International Journal of Distributed Energy Resources
Vol 3:1, p 31-45.

<http://www.ts-publishers.com/>

Keywords: distributed energy; MV-grid; photovoltaics; storage

ABSTRACT

This paper investigates the influence of energy storage on the network impacts from large-scale PV schemes applying a dynamic computational method. A total of 11 case studies were computed applying a simulation tool that combines power-flow calculations with distributed generation and storage models. Different storage schemes, PV sizing and climatic zones have also been considered.

The study indicates that using a storage of 1kWh per 1kW_p PV may reduce the PV induced over-voltage by 30-100% depending on the case. The benefits were more distinctive in a southern climate than in northern latitudes where the mismatch between solar output and load is more severe at the seasonal scale. With careful siting of the PV units in the grid, significant benefits can be achieved even without storage. These benefits are achieved by placing PV systems in strong grid locations and avoiding the weak ones.

1 INTRODUCTION

The photovoltaic (PV) market has grown in average by more than 30% in the recent years, as a power generation option has been broadly promoted in several countries [1]. If the present trend is lasting, then widely spread PV generation may become common. Most of the new PV capacity has been installed into the distribution grid as distributed generation [2]. The solar irradiation is the highest at noon when the domestic consumption is on intermediate level. As a consequence, widely spread PV generation may induce problems into a distribution grid located in a residential area.

To reduce the influence of the noon-time PV generation peak to the local grid, a storage unit can provide an attractive solution. If the excess PV generation is stored and later released during the evening peak consumption hours the potential problem can be turned into a benefit for the network. The main questions in deploying a storage unit in a distribution network are the storage siting considering also the network topology, size of the storage versus locally installed PV capacity, and storage control strategies. Typically the smoothing of the PV production peak requires only daily electricity storage.

A short review on the most common energy storage technologies can be found in [3]. Additional discussion on grid connected storage applications has been given by Price et al. [4] and Cheung [5].

Modern PV technologies and their development have been discussed by Green [6], van der Zwaan [7] and also in a report by IEA-PVPS [8]. Technical issues in connecting PV technologies to grid have been discussed in depth by Verhoeven [9].

The authors have in an earlier article already analyzed grid integration of PV without energy storage [10]. The focus of this article is on investigating how electrical storage may influence the impacts of large-scale PV in the distribution network, and in particular to find solutions to minimize the adverse effects. Mainly static network issues will be addressed, including long-lasting over-voltages and increased network losses. There are also many other technical issues related to network power quality and safety, such as transient voltage variations, harmonic distortion of the network voltage, and the overall impact of the distributed generation on existing distribution system protection. These issues are beyond the scope of this paper.

2 METHODOLOGY

The power distribution system is modeled in this paper by applying a simulation tool DESIGEN (decentralized system simulation tool for optimized generation) developed at Helsinki University of Technology [10]. This program combines power flow calculations, models for distributed power generation and storage, and custom load data. The static power flow effects in the modeled system are typically

simulated using an 1 h time step. These main parts of DESIGEN are discussed in the chapter below, except the electrical storage approach, on which there is an own chapter.

2.1 Main parts of system simulation model

The power flow calculations applied here have been done with a radial network typical for residential areas where distributed photovoltaic (PV) generation will be mostly applied. The network node voltages \underline{U}_k^t are iteratively computed with equation

$$\underline{U}_k^{t+1} = \underline{U}_i^{t+1} - \frac{\underline{Z}_k \underline{P}_k^{*t}}{\underline{U}_k^{*t}} \quad (1)$$

where i refers to the node where node k gets its current and t refers to the iteration round. \underline{Z}_k is the impedance between nodes i and k and \underline{P}_k^t is the power flow through the node k . By using the result from a previous iteration round as an initial value for the next iteration, the computation converges towards the solution. A more detailed description of the method can be found elsewhere [10, 11].

A temperature dependent PV generation model has been integrated to DESIGEN to simulate large scale PV systems [10]. The model calculates the output power P_{PV} of PV-arrays as follows:

$$P_{PV} = A_{PV} \times I \times \eta \quad (2)$$

where A_{PV} is the total array area, I the incident solar insolation, and η the total system conversion efficiency of the photovoltaic system. The solar radiation on the PV surface is calculated using standard incidence angle formulas for beam and diffuse solar radiation [12], and the time step applied in the calculations is 1 h. The system efficiency η depends on three parameters, the solar module efficiency and its temperature dependence, and the DC to AC conversion efficiency that includes losses in cabling etc. To account for possible shadings or obstructions at low solar elevation in urban environments, Eq. (2) is subject to a threshold value, or $P_{PV} = 0$ if $I < 50 \text{ W/m}^2$.

The customer load data applied in this work has been generated by the load model of Paatero and Lund [13]. The load model generates household (hh) consumption data with a bottom-up approach using a broad range of input data. The data needed includes the mean electricity consumption rate and seasonal variation with a weekly resolution. Additionally, for the appliances to be included into the model, their mean daily consumption profiles, the cycle lengths, power levels, and standby power levels are needed. Finally, the mean saturation levels per hh and average usage per day of the appliances need to be defined. Applying the input data, realistic hourly load profiles can be stochastically generated on the individual hh level for a large number of households. The Helsinki and basic Lisbon load data from [13] are used in this article.

2.2 Storage method

The main purpose of the storage in this paper is to reduce the daily photovoltaic (PV) generation peak by storing part of the generated electricity and to deliver it in the evening hours during high consumption. To achieve the required storage performance, the capacity $Q_{cap,ann}$ needed for storing the daily excess PV power on annual basis is defined here as

$$Q_{cap,ann} = \max_{ann}(Q_{cap,daily}) \quad (3)$$

where

$$Q_{cap,daily} = \int_{\Delta t_{noon}} \eta A_{PV} I_{noon} - W_{noon} \quad (4)$$

In Eq. (3) the function \max_{ann} seeks the annual maximum of the daily excess energy $Q_{cap,daily}$ generated around the noon time Δt_{noon} . In Eq. (4), I_{noon} is the intensity of the irradiation and W_{noon} is the local consumption during the noon time.

The stored energy will be discharged in the evening. If no optimal discharge is considered, the storage will be discharged using a high discharge rate P_{max} . If the reduction of evening consumption peak is beneficial, the storage can be discharged steadily during the main consumption peak interval Δt_{peak} , with a discharging power P_{dis} equal to

$$P_{dis} = \frac{Q_{cap,daily}}{\Delta t_{peak}} \quad (5)$$

This reduces the local evening consumption peak by P_{dis} . The non-optimized as well as the evenly distributed discharge methods are illustrated in Figure 2.1. The 1st strategy refers to the non-optimized discharge and the 2nd to the evenly distributed discharge in Figure 2.1.

When optimizing the use of the storage, two main criteria are applied. The first primary criterion is to keep the overall system voltage within or as close as possible the allowed voltage variation limits. Here a $\pm 2,5\%$ voltage variation will be allowed. This is a compromise between the urban (0.5-2.0%) and rural (5-15%) voltage variation limits given by ABB [14]. The secondary criteria, which is only applied when the primary criteria is fulfilled, is to minimize the overall power fed from the mains to the system.

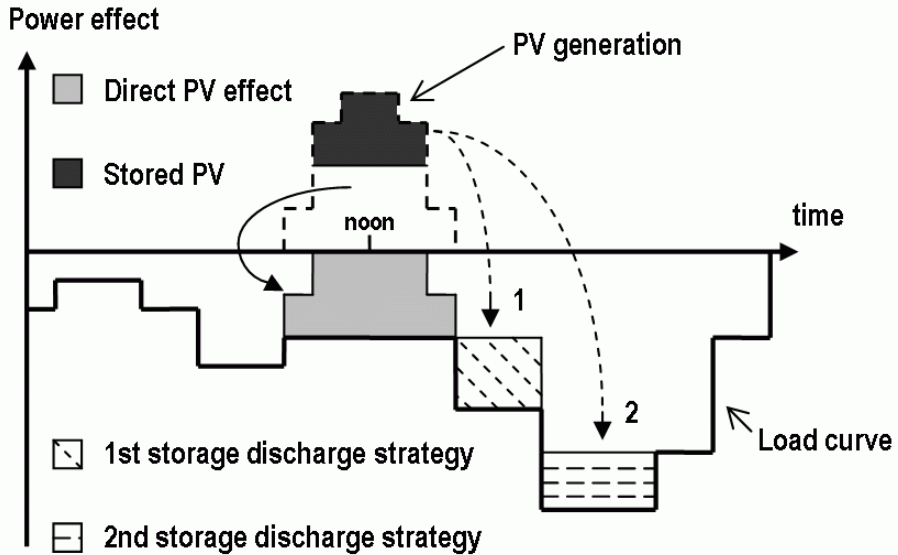

Figure 2.1: Schematic presentation of the two storage control strategies applied. The 1st discharge strategy refers to non-optimized discharge, where no evening peak reduction is gained. The 2nd strategy distributes the stored electricity evenly over the evening peak hours, reducing the evening peak correspondingly.

To achieve these criteria, three parameters have been varied. Firstly, the interval of the noon charging period Δt_{noon} can be varied with the charging beginning at an even hour between 8 and 12, and ending between 13 and 19 hours. Secondly, the hourly charging rate of the storage can be varied; here we used three levels of 12.5%, 18.75%, and 25% of the total storage capacity charged per hour. Thirdly, the evening discharging period Δt_{peak} can be varied with the storage discharging starting between 20 and 21, and ending between 23 and 24 hours. The optimization of the system has been done on an annual basis, in which case the days with highest PV generation days and days with highest consumption dominate the optimization.

3 INPUT DATA

The aim of the case studies is to determine the effects of widespread PV generation to a medium voltage distribution grid in a city environment. To address the effects of different climatic conditions, causing changes both in irradiation and consumption patterns, two household (hh) load sets from two different climates (Finland and Portugal) were compared. To assess the influence of storage, all case studies were done with and without storage. Also, the influence of local siting of

both PV and storage were considered. The final input data sets included the following:

- 2 sets of hh consumption profiles from two different climates, 1 from Lisbon in Portugal and 1 from Helsinki in Finland;
- 2 penetration levels of PV power generation without storage;
- 2 citing strategies for PV power generation without storage;
- 2 penetration levels of PV power generation with storage;
- 3 storage citing strategies coupled with 2 PV citing strategies.

This yields $2 \times (2 \times 2 + 2 \times 3) = 20$ cases. In addition, 2 reference cases without PV and storage were computed, resulting 22 case studies. The 11 cases for each climate have been labeled as follows:

- A: No PV nor storage;
- B1: PV without storage, 0.5 kW_p / hh;
- B2: PV without storage, 1.0 kW_p / hh;
- B3: PV without storage, 1.5 kW_p / hh in 1/3 of the houses;
- B4: PV without storage, 3.0 kW_p / hh in 1/3 of the houses;
- C1: PV with storage, 0.5 kW_p / hh and 0.5kWh / hh;
- C2: PV with storage, 1.0 kW_p / hh and 1.0kWh / hh;
- C3: PV with storage, 1.5 kW_p / hh and 1.5kWh / hh, in 1/3 of the houses;
- C4: PV with storage, 3.0 kW_p / hh and 3.0kWh / hh, in 1/3 of the houses.
- C5: PV with storage, 0.5 kW_p / hh and two large centralized 6.2MWh (LIS) or 6.9MWh (HEL) storages;
- C6: PV with storage, 1.0 kW_p / hh and two large centralized 12.5MWh (LIS) or 13.7MWh (HEL) storages.

Cases C1-6 have their storage control strategy optimized. In addition, the siting of the PV was optimized in cases B3-4 and C3-4, while in cases C3-4 it was combined with storage. Also, in cases C5 and C6 the PV generation was evenly distributed among all households, while the storage siting was optimized.

3.1 Helsinki and Lisbon

Two different climatic zones, one South-European and one North-European were chosen to account for the possible differences caused by the weather conditions. The local climate influences strongly the solar insolation levels that influence directly the PV electricity production. In addition, the climate affects consumer behavior that in turn is connected to the electric load. Even in our case, where direct electric heating is not considered [13], the weather plays a clear role in the

load pattern. As the load model is based on average weekly seasonal patterns only, the effects of daily weather on load comes only through the statistical fluctuation. Therefore the effects of a sunny day will be seen in the PV electricity generation, but not necessarily in the load patterns. The seasonal patterns in the Helsinki and Lisbon consumption data are, however, very different.

In Helsinki, the high consumption peak is in late autumn, while the whole winter has high consumption levels. Together with the northern location this means that there is little or no PV generation during the day of highest consumption peak in the year. Thus it will not be possible to reduce the consumption peak with PV, unless a seasonal-type storage is used. Furthermore, the summer is a low consumption period for Helsinki and therefore only a limited amount of stored PV electricity can be utilized. The Helsinki annual variation in both consumption and PV generation are much greater than in Lisbon [13].

In Lisbon the annual high in consumption occurs during the summer months with the peak in end of July and the beginning of August. This coincides well with the annual PV peak that also occurs during the summer. However, Lisbon also has significant PV generation during the winter, contrary to Helsinki. As a result, PV generation can be effectively utilized in Lisbon, and the stored PV electricity can be employed to reduce the consumption peaks. Thus, in Lisbon, both the increased grid-voltage-level due to excessive PV generation and the evening consumption peaks can be tackled with electricity storage.

3.2 Network

The applied network in this paper is similar to the tree-type network the authors have used elsewhere [13]. However, the dimensions of the network have been changed to correspond better to urban medium voltage distribution network. Also, here one full network branch has been simulated without any reduced nodes. The applied network with 78+1 nodes has been presented in Figure 3.1, where the node 1 is the node feeding the network and it has no load directly connected to it like in the 78 load nodes.

The load data was applied evenly to all the 78 load nodes of the network. One node corresponds to 320 households in Lisbon, and 352 households in Helsinki, resulting a total of 24960 and 27456 households, correspondingly. One household has an annual electricity demand of 2360 kWh in Lisbon, and 1859 kWh in Helsinki. This makes the total annual load in the network 58.9 GWh in Lisbon and 51.0 GWh in Helsinki cases. The total amount of network load was such that in both the climates described above the network become fully loaded when no PV and storage was included. In practice, this means that the transformer in the feeding node of the network was assigned a voltage of 20500V, while the low-voltage end was during the worst hour of the year slightly above 19500V. This limits the total voltage variation to $\pm 2.5\%$ of nominal voltage, which is somewhat more than the ABB urban recommendation [14], but consistent with the earlier work by the authors [13].

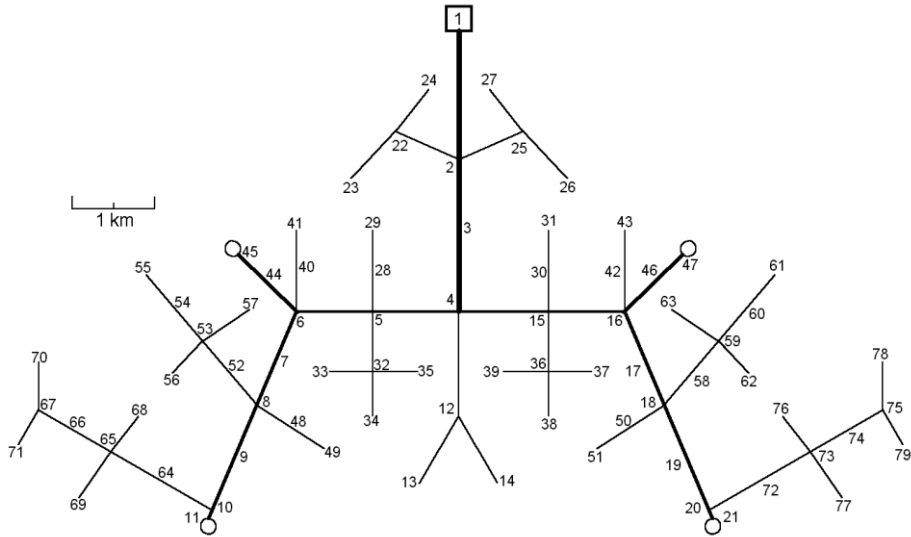

Figure 3.1: Network topology used in reduced form. Numbers in figures correspond to the network nodes.

3.3 PV generation

The PV penetration levels in this work have been chosen in such a way that they will cause over-voltage events in the network without storage. The total PV generation in the network will be clearly higher than the total consumption during some hours of the year. Two cases (B1 and B2) have been chosen so, that when the PV is evenly distributed to the network, the case with lower PV penetration (B1) will cause only slight over-voltage events. The case with higher PV penetration (B2) will have two times more PV.

Two PV siting strategies were applied to reveal how large influence a siting strategy can have to the adverse effects from the PV generation to the network. The basic case was to distribute the PV systems evenly overall load nodes. The second siting scenario was to apply the same amount of PV but to only one third of the network load nodes.

3.4 Storage

The cases with electricity storage focused on the question of storage siting in the network to maximize the benefits from storage. Three cases with different storage siting strategies were applied. In the first strategy (cases C1 and C2), the storage capacity was evenly distributed to all the network load nodes. This storage strategy was applied only in connection with the evenly distributed PV generation cases. The second strategy (cases C5 and C6), also applied with PV in all nodes, employs two centralized large storage units that will be optimally located in the network. The third strategy (cases C3 and C4) is coupled with the PV scenario where only

one third of the load nodes have PV and a storage unit will be connected to each of the PV generation nodes.

The total size of electrical storage is fixed to the total PV amount installed to the system. For each installed kW_p of PV there is one kWh of storage capacity available in the system.

4 RESULTS

The basic control strategy applied in the case studies is illustrated in Figure 4.1, where a typical charge – discharge cycle for a node with both PV and storage is shown. In the next, main results of the case studies are discussed, including the effects of climate, PV and storage system penetration levels and system topology.

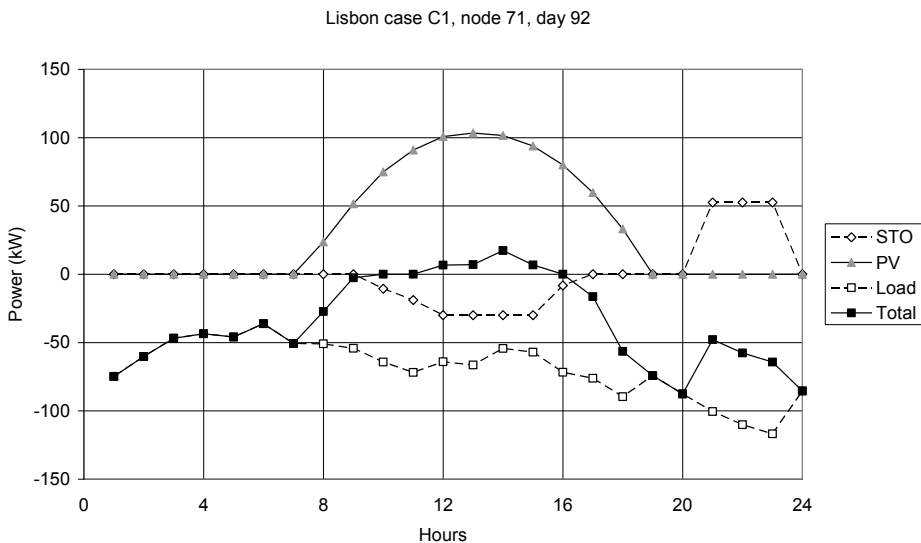

Figure 4.1: Typical day with storage charge-discharge cycle in Lisbon case C1.

4.1 Effect of climate

The load peak in Helsinki occurs on a winter day when no PV generation is available. Thus, the whole optimization of Helsinki PV utilization was focused on reduction of the annual maximum voltage and minimization of the total load from the mains. The minimum voltages could not be influenced as no stored PV was available during the winter peak day. As a result, the Figures 4.2-3 from the case studies in Helsinki include the maximum voltage curves only whereas the minimum voltage curve was not presented as it remains unchanged.

With Lisbon data, a much better performance can be found. The milder diurnal fluctuation together with the fact that in Lisbon the maximum consumption coincides with the maximum PV generation season provided a good performance

for the storage in the Lisbon cases (Figures 4.4-6). Even without storage the performance of PV in the Lisbon cases was superior to Helsinki. Here also annual minimum voltage profiles are shown as the storage use modifies the voltage level.

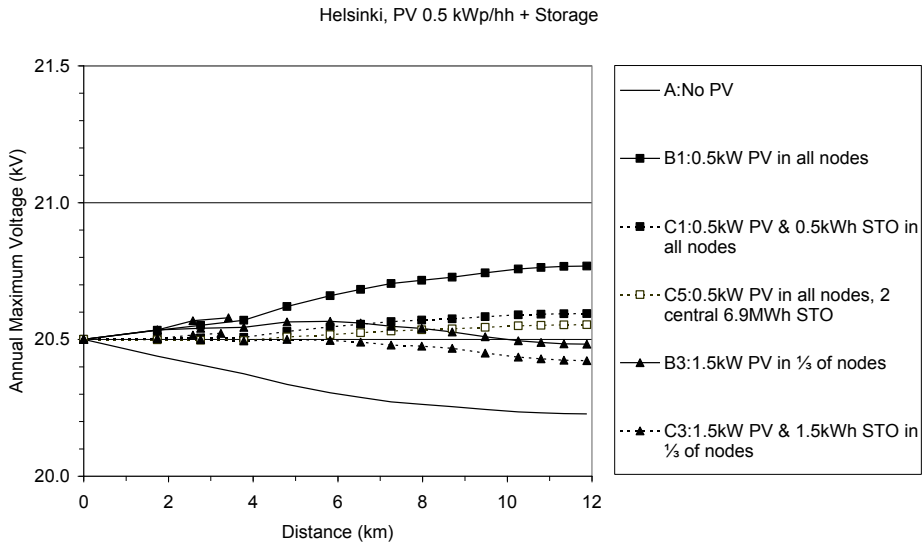

Figure 4.2: Annual maximum voltage profiles in Helsinki for cases A, B1, B3, C1, C3, and C5. The installed PV capacity totals 0.5 kW_p / hh, and the corresponding storage capacity 0.5 kWh / hh.

4.2 Effect of PV and storage penetration levels

The two penetration levels for PV generation and storage provided only a limited view on their effects to the network. The 0.5 kW_p / household (hh) use caused only a small network over-voltage that could be mostly or totally compensated by the storage (cases B1 and C1). In Helsinki (Figure 4.2), the annual maximum over-voltage was reduced 65%, while in Lisbon (Figure 4.4) it was completely removed. The effects from the higher 1.0 kW_p / hh PV use would, in contrast, be beyond the range of response by the applied storage (cases B2 and C2). In Helsinki (Figure 4.3), the maximum over-voltage was reduced by 36%, while in Lisbon (Figure 4.5) the reduction achieved was 73%. The Lisbon success partly relies on the 0.6% reduction in the feeding voltage of node 1.

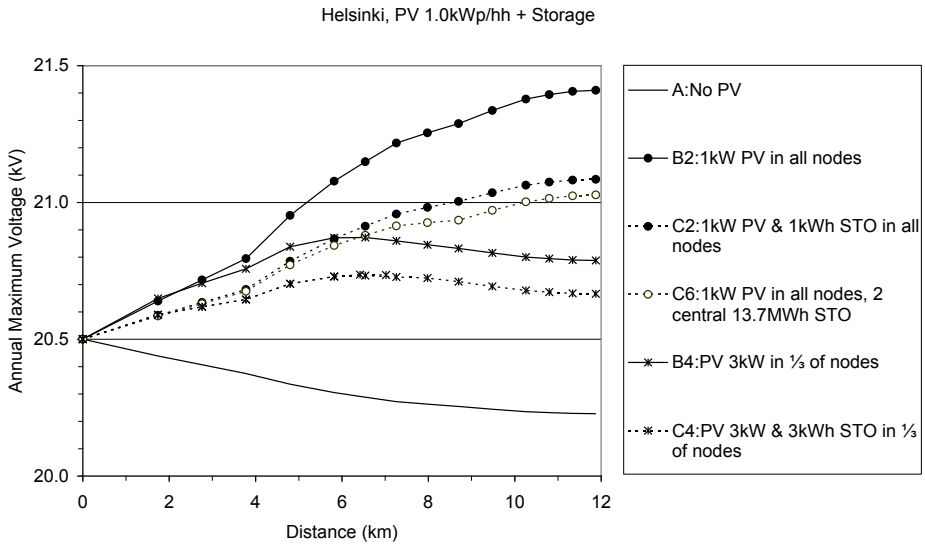

Figure 4.3: Annual maximum voltage profiles in Helsinki for cases A, B2, B4, C2, C4, and C6. The installed PV capacity totals $1.0 \text{ kW}_p / \text{hh}$, and the corresponding storage capacity $1.0 \text{ kWh} / \text{hh}$.

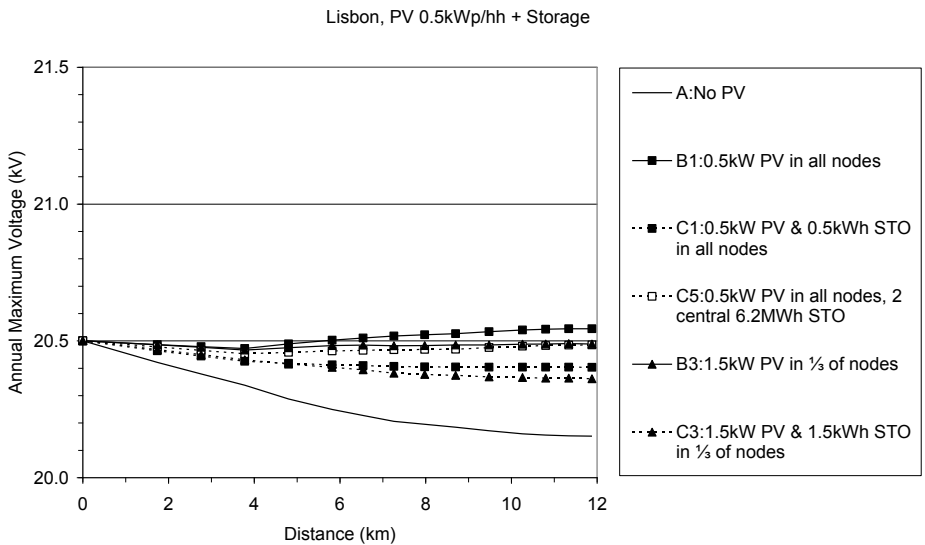

Figure 4.4: Annual maximum voltage profiles in Lisbon for cases A, B1, B3, C1, C3, and C5. The installed PV capacity totals $0.5 \text{ kW}_p / \text{hh}$, and the corresponding storage capacity $0.5 \text{ kWh} / \text{hh}$.

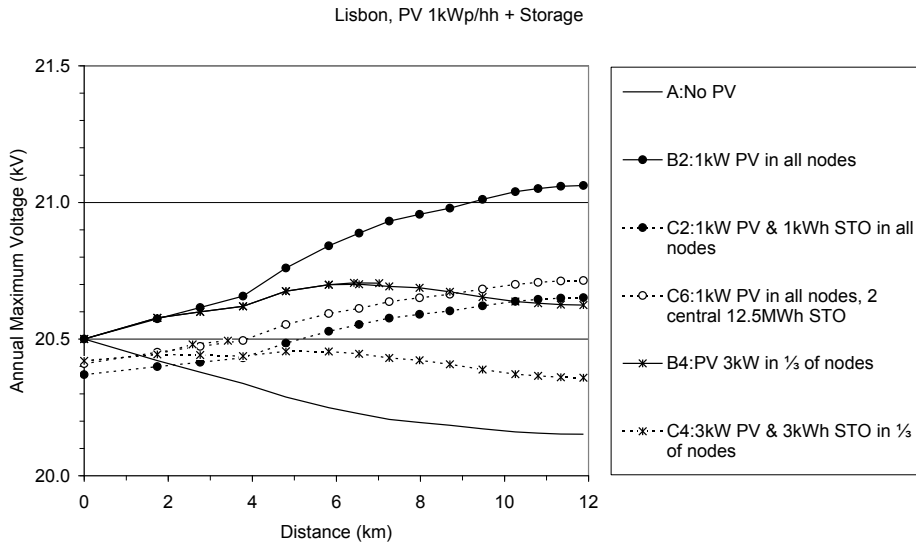

Figure 4.5: Annual maximum voltage profiles in Lisbon for cases A, B2, B4, C2, C4, and C6. The installed PV capacity totals $1.0 \text{ kW}_p / \text{hh}$, and the corresponding storage capacity $1.0 \text{ kWh} / \text{hh}$.

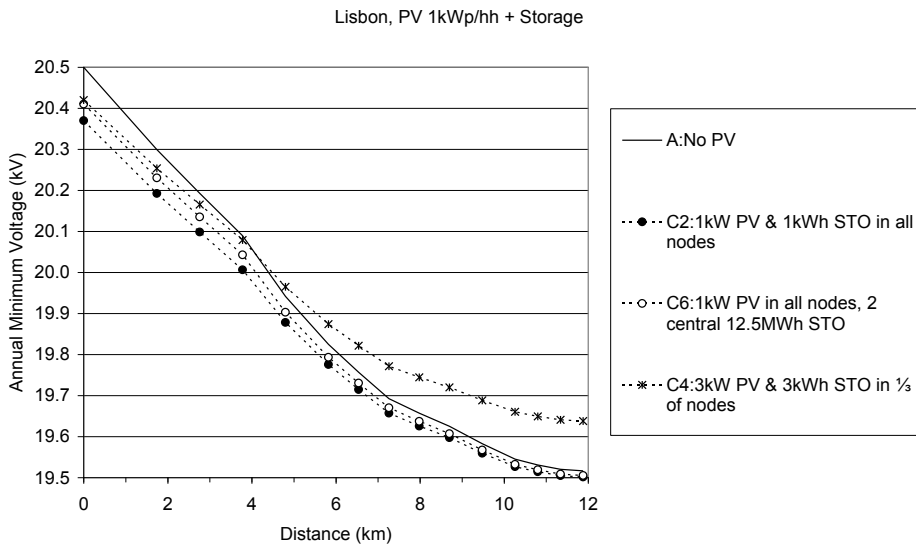

Figure 4.6: Annual minimum voltage profiles in Lisbon for cases A, C2, C4, and C6. The installed PV capacity totals $1.0 \text{ kW}_p / \text{hh}$, and the corresponding storage capacity $1.0 \text{ kWh} / \text{hh}$.

4.3 Effect of siting and network topology

Through changing the siting of both the PV generation and storage in the network, significant changes can be achieved in the maximum voltage levels. Additionally, the siting influences the total power demand of the system. When PV without storage is considered (B1-4), limiting PV use to $\frac{1}{3}$ of the nodes (B3 and B4) reduces the over-voltages in the network roughly by $\frac{2}{3}$, as seen in Figures 4.2-5. In cases B3 and B4 the PV was mainly sited as close as possible to the node 1 in Figure 3.1, as seen from the list of PV nodes in Table 4.1.

Table 4.1: Optimal PV siting when only $\frac{1}{3}$ of the nodes is used

<i>Case</i>	<i>Location</i>	<i>Nodes with PV generation (and storage)</i>
B3	Helsinki	2-9,12,15-19,22-28,30,32,36,44,46
B4	Helsinki	2-8,12-18,22-28,30,32,36,44,46
C3	Helsinki	2-10,12,15-20,22,24,25,27,28,30,32,36,44,46
C4	Helsinki	2-9,12,15-19,22-28,30,32,36,44,46
B3	Lisbon	2-8,10,12,15-18,20,22,25,32,36,44,46,53,59,65,67,73,75
B4	Lisbon	2-9,12,15-19,22-28,30,32,36,44,46
C3	Lisbon	2-8,10,12,15-18,20,22,25,32,36,44,46,53,59,65,67,73,75
C4	Lisbon	2-9,12,15-19,22-28,30,32,36,44,46

In Helsinki (Figures 4.2-3), the over-voltage from 1kW_p PV / hh is reduced by 59%, while with the 0.5kW_p PV / hh case the over-voltage is reduced by 70%. In Lisbon (Figures 4.4-5), the 0.5kW_p PV / hh case with limiting PV to $\frac{1}{3}$ of the nodes removes the over-voltage completely, while with the 1kW_p / hh case the reduction is 63%.

When the storage options are additionally considered the outcome becomes more complex. If PV siting is not limited to $\frac{1}{3}$ of the nodes (cases C1-2 and C5-6), the maximum voltage is reduced more when a centralized storage scheme is applied in almost all cases, except in the Lisbon cases C1 and C5 (in Figure 4.4). The voltage remains in C1 and C5 within the allowed system boundaries even without storage. Thus the centralized storage unit can be placed to minimize network losses which is not possible if storage units are evenly distributed among the nodes.

The cases C3-4 with PV and storage siting limited to $\frac{1}{3}$ of the nodes give the best performance among all the case studies. In Helsinki case C4 with 1kW_p PV / hh and storage (Figure 4.3) the over-voltage is reduced by 37% when compared with the case B4 without storage. In the case C3 with 0.5kW_p PV / hh and storage

(Figure 4.2), 72% reduction in the over-voltage is experienced, when compared with case B3.

The corresponding Lisbon cases show a different behavior. The case B3 with 0.5kW_p PV / hh and no storage remains already within the voltage limits and the storage (C3) only improves the system efficiency. However, the energy savings achieved are less than 0.05% of the total consumption. Thus the use of storage is not justified there. In contrast, in the case C4 with 1kW_p PV / hh and storage the over-voltage remaining in case B4 is completely removed as shown in Figure 4.5. As a result, the case C4 keeps the network voltage completely within the allowed limits.

It should be noted, however, that the good performance in case C4 is partly due to utilization of the increase in minimum voltages that can be seen in Lisbon cases with storage in Figure 4.6. With case C4 this significant increase in minimum voltages allows compensation of network over-voltage with decrease in the feeding voltage, as shown in Figure 4.5. Similar method has been applied in cases C2 and C6 as well.

5 CONCLUSION

In this paper the influence of energy storage on the network impacts from large-scale PV schemes has been investigated using a dynamic computational method. Several cases employing different storage schemes and PV sizing as well as two different climatic zones were considered.

The main results of the study indicate that using a relatively small storage of 1kWh per 1kW_p PV may reduce the over-voltage by 30-100% depending on the case. The benefits were more distinctive in a southern sunny climate than in northern latitudes where the mismatch between solar output and load is more at seasonal scale rather than daily only.

A careful citing of the PV units in the distribution network may provide significant advantages even without storage. This may be accomplished through avoiding placement of the PV systems in the weak or tail parts of the grid. With an optimal siting scheme, the evident benefits from storage may reduce by two thirds compared to a non-optimal scheme.

6 REFERENCES

- [1] Beise, M.: *The international adoption of photovoltaic energy conversion*. International Journal of Energy Technology and Policy, **2(3)**, pp. 272-283, 2004.
- [2] IEA-PVPS: *Trends in photovoltaic applications - survey report of selected IEA countries between 1992 and 2003*. IEA-PVPS T1-13:2004, 2004

- [3] Lund, P.D. Paatero, J.V.: *Energy storage options for improving wind power quality*. Proceedings of Nordic Wind Power Conference, Espoo, Finland, 2006.
- [4] Price, A. Thijssen, G. Symons, P.: *Electricity storage, a solution in network operation?* Proceedings of Distributech Europe, Vienna, Austria, 2000.
- [5] Cheung, K.Y.C. Cheung, S.T.H. De Silva, R. G. Navin Juvonen, M.P.T. Singh, R. Woo, J.J.: *Large-scale energy storage systems*. Available at http://www.doc.ic.ac.uk/~mpj01/ise2grp/energystorage_report/storage.html. Accessed August 15, 2006.
- [6] Green, M.A.: *Crystalline and thin-film silicon solar cells: State of the art and future potential*. Solar Energy, **74(3)**, pp. 181-192, 2003.
- [7] van der Zwaan, B. Rabl, A.: *Prospects for PV: A learning curve analysis*. Solar Energy, **74(1)**, pp. 19-31, 2003.
- [8] IEA-PVPS: *Trends in photovoltaic applications - survey report of selected IEA countries between 1992 and 2004*. IEA-PVPS T1-14:2005, 2005
- [9] Verhoeven, S.A.M.: *Utility aspects of grid-connected photovoltaic power systems*. , IEA PVPS T5-01:1998, 1998.
- [10] Paatero, J.V. Lund, P.D.: *Effects of large-scale photovoltaic power integration on electricity distribution networks*. Renewable Energy, In Press.
- [11] Jenkins, N. Strbac, G.: *Impact of embedded generation on distribution system voltage stability*. IEE Colloquium on Voltage Collapse, London, UK, 1997.
- [12] Duffie, J.A. Beckman, W.A.: *Solar Engineering of Thermal Processes*. ,2nd ed. John Wiley & Sons. Inc., New York, U.S.A, 1991. pp. 919.
- [13] Paatero, J.V. Lund, P.D.: *A model for generating household electricity load profiles*. International Journal of Energy Research, **30(5)**, pp. 273-290, 2006.
- [14] ABB, *Technical Information and Tables (in Finnish)*. 10th ed. Ykkös-Offset Ltd., Vaasa, Finland, 2000. pp. 626.

NOMECLATURE

- A total PV array area;
- hh household;
- I incident solar insolation;
- P power;
- PV photovoltaic;
- Q energy;
- STO storage;

t time;

Greek letters

Δ a step in a variable;

η total system conversion efficiency

SUBSCRIPTS

ann annual;

cap capacity;

daily daily;

dis discharge;

i,k node indexes

noon time period surrounding the noontime;

p,peak maximum value over the time period;

PV photovoltaic

SUPERSCRIPTS

t iteration round index